

DSM2

DMC2 Supply Module



Specification Sheet

Controllers > DMC Modules



Single-Phase or Three-Phase power for the DMC2

Refer to the DMC2 Specification Sheet for more information.

Specifications

Electrical		Physical	
Supply Type	Single-phase Three-phase, four wire (A)	Supply Terminals	4 x screw terminal (L1, L2, L3, Neutral) (Earth link bar provided)
Single-Phase Supply	120/230/277 VAC @ 63 A	Supply Terminal Conductor Size	16 mm ² (#6 AWG) (max)
Three-Phase Supply	120/230/277 VAC (±10%) @ 32 A/phase		
IEC Overvoltage Category	III		

Electrical Drawing

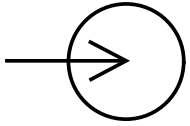

3 ~ 120/230/277 V ~ ± 10% 3 x 32 A
 1 ~ 1 x 63 A

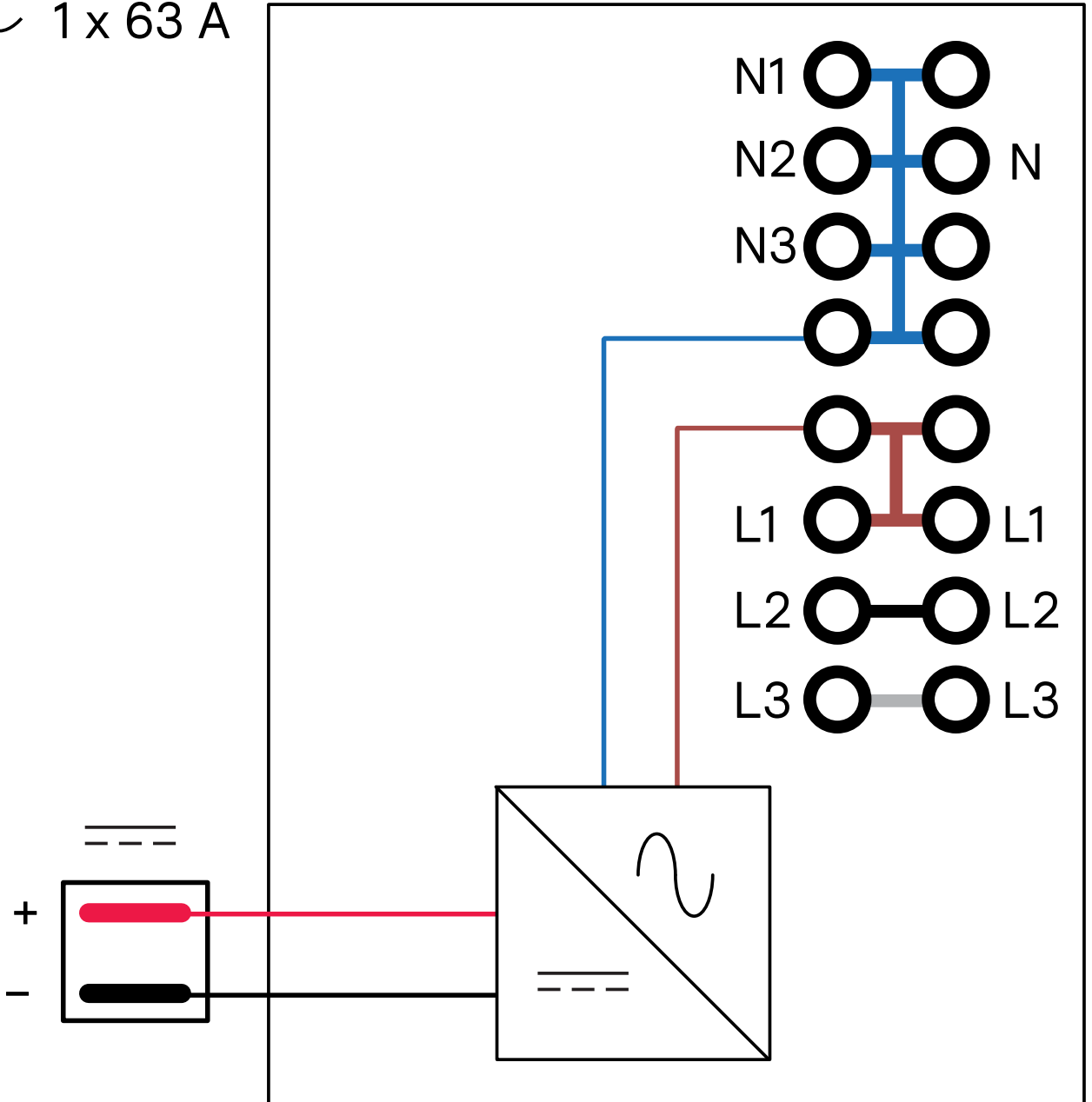

Ordering Codes

Product		12NC
DSM2	DMC2 Supply module (Also suitable for UKCA markets)	913703500509