

PHILIPS
dynamilite



Inspired design, ultimate control

Beautiful interface solutions with user-friendly functionality for every interior

European version

Contents

| | |
|-------------------------------|---------------|
| Panel Feature Overview | P3 |
| Panel Finishes | P4 |
| Array Design Language | P5 |
| Revolution UI Series | P6 |
| Revolution Button | P7 |
| Revolution Display | P8 |
| Revolution Multigang | P9 |
| Antumbra UI Series | P10 |
| Antumbra Button | P11 |
| Antumbra Display | P12 |
| Antumbra Touch | P13 |
| Touchscreens | P14-15 |
| Mobile Apps | P16-17 |
| Design Studio | P18 |
| Technical Information | P19 |



Our Panel Features



Intuitive interaction, tactile feedback

Large, clean buttons provide a canvas to create intuitive, simple interfaces that match your style.

Major/Minor button options help relay the importance of primary functions such as master buttons, while a positive tactile 'click' gives the user an instinctive confirmation of their action.



Back-lit halo and status indicators

An easy to use interface in daylight or darkness. Text and icons are laser cut into the fascia in black or white to contrast with the button colour and finish.

Indicator back lighting can be off, dim or bright to indicate the functional state of the button or use the integrated light sensor to adjust the relative brightness throughout the day.



Back-lit buttons

RGB backlit buttons can be independently configured from an endless colour palette, responding dynamically to a button press or system event.

The backlights fade when Revolution is not in use, enabling the panel to blend into its environment, reducing light pollution and conserving energy.



Post-installation changes

Display graphics, time-out periods, behaviours or scene settings can easily be changed over the network after install using Dynalite's bulk update tool.



Beautiful materials that match

Our user interfaces allow for complete design and finish uniformity across the room, including thermostat, room status, lighting, fan and curtain controls.

Matching electrical accessories complete the room with the same finishes including power, data and AV outlets for a simple unified approach.



Multi language and icon labeling

Button labelling is available in a choice of Arabic, Chinese, English, Hebrew, Japanese and Korean with font size options.

Select from the icon library for a visual representation of button functions that transcends language barriers



Proximity and ambient light sensors

Discreet proximity and ambient light sensors bring the panel to life when a user approaches in darkness featuring back-lit text and icons or a soft 'halo' of light.

This seamless and automatic behaviour is immediately intuitive for users, fading back to darkness when they move away for a complete blackout overnight.



Temperature and humidity sensors

Discreet temperature and humidity sensors in every panel, provide seamless interactions and specific local data for climate control.

Stunning finishes

Revolution and Antumbra finishes combine style and durability. They are scratch- and fingerprint-resistant and easy to clean. In addition, Antumbra provides the option to mix and match different rim colours.

Satin

Hybrid layered PVD finish. Coloured buttons have a brushed metal look



Laquer

High-gloss polycarbonate

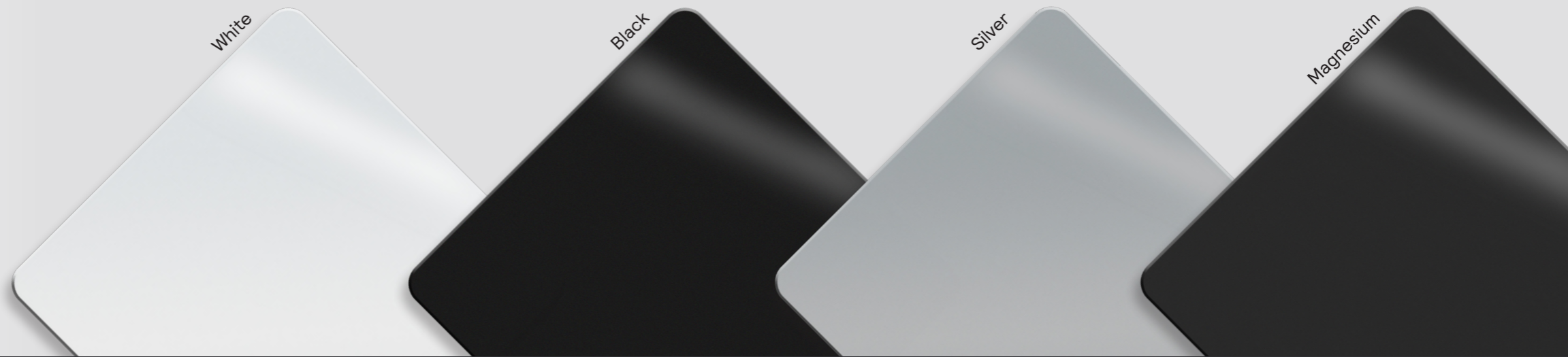

Luxe

Solid brushed aluminium anodised into six standard finishes



Revolution



Revolution Button

RevolutionButton leads the way in modular UI design. Its sleek, contemporary exterior can be tailored to suit any environment.

Revolution has appealing proportions with large, tactile buttons that are RGB backlit and provide generous space for labelling. This results in an approachable UI that can be easily operated by a range of audiences regardless of age, ability, or language.



Finishes

Luxe fascias



Aluminium

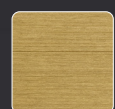

Gold

Satin fascias



Aluminium

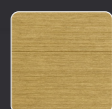

Gold

Laquer fascias

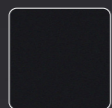

Black

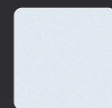

White

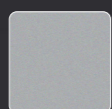

Silver

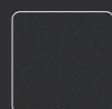

Magnesium

Rim

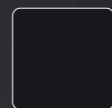

Black

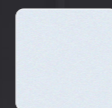

White

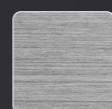

Aluminium

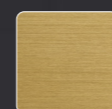

Gold

Layouts

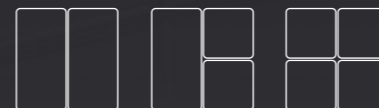

Features



RGB backlit buttons



Temperature & humidity sensors



Bulk Uploads



Proximity detection

Revolution Display

Revolution Display is a contemporary full-colour capacitive touchscreen that dynamically responds to user presence. Add up to 16 configurable pages of control widgets to perform a variety of functions, from lighting scene selection and opening/closing window coverings to fan speed, temperature setpoint adjustment and advanced custom macros.



Finishes

Rim

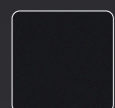

Black

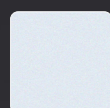

White

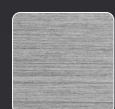

Aluminium

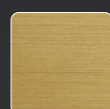

Gold

Display Themes

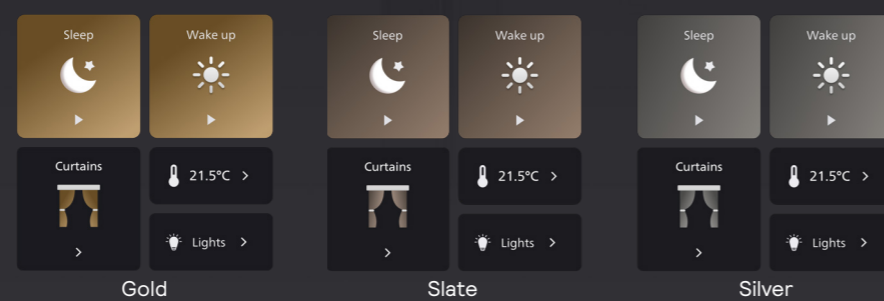

Gold

Slate

Silver

Features



Multiple pages



Temperature & humidity sensors



Bulk Uploads



Proximity detection

Revolution Multigang

The Revolution Multigang range is designed to satisfy high-end market expectations by offering multiple user interface mounting options.

Two and three gang frames are available that include Button, Display and V8 modules, enabling customers to select their preferred combination.

Multigang frames are available in the same colours and finishes as single gang Revolution button user interfaces, providing a seamless installation of multiple modules.



Finishes

Luxe fascias

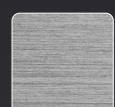

Aluminium

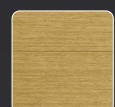

Gold

Satin fascias

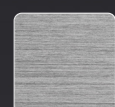

Aluminium

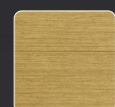

Gold

Laquer fascias

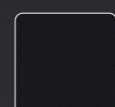

Black

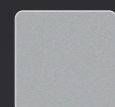

Silver

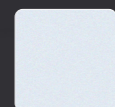

White

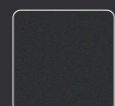

Magnesium

Rim

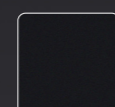

Black

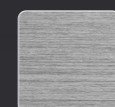

Aluminium

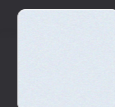

White

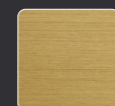

Gold

Triple gang layouts

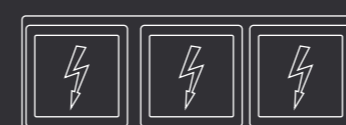
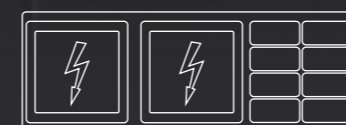
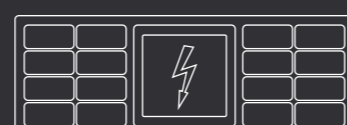

Double gang layouts

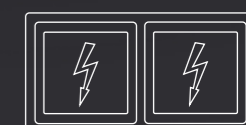
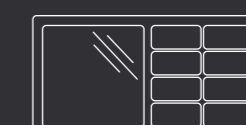
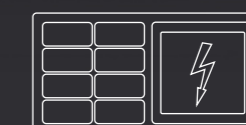

Antumbra



The stunning Antumbra range has a surprising number of features, packaged in a choice of three designs that redefine the concept of minimalist chic.

When you first encounter Antumbra, it detects your body's own electrical field and wakes up with an inviting wall-wash lighting effect. With inbuilt temperature, humidity and light sensors, the Antumbra range offers an unparalleled balance of form and function.

Antumbra Button

Antumbra Button has large mechanical buttons available in 2, 4, or 6 button variants. Different finish options are available for the fascia and rim of the keypad and all colour options can be mixed and matched. Customised labelling of text and icons can also be added.



Finishes

Luxe fascias



Noir



Prestige



Jet



Aluminium

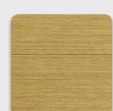

Gold

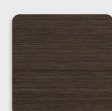

Vintage

Laquer fascias

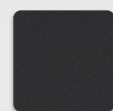

Magnesium

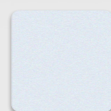

White

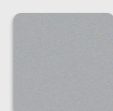

Silver

Rim

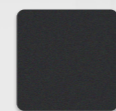

Magnesium

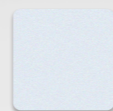

White



Aluminium



Chrome

Layouts

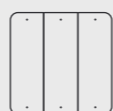
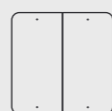

Features



Halo effect



Temperature & humidity sensors



Bulk Uploads



Proximity detection

Antumbra Display

AntumbraDisplay features six configurable buttons and a central LCD display. It includes a temperature sensor and the latest in field-effect technology to detect user presence.

The display can be configured to present multiple pages of functions and system information, including lighting scene or level, air conditioning, fan, current temperature, and setpoint.



Finishes

Luxe fascias

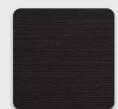

Noir



Prestige



Jet



Aluminium



Gold

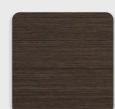

Vintage

Laquer fascias

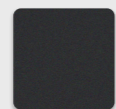

Magnesium

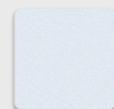

White

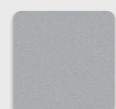

Silver

Rim

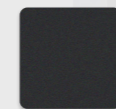

Magnesium

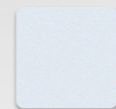

White



Aluminium



Chrome

Layouts

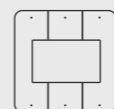
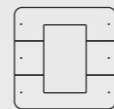

Features



Halo effect



Temperature & humidity sensors



Bulk Uploads



Proximity detection

Antumbra Touch

The AntumbraTouch has a smooth glass finish and uses capacitive touch technology to detect finger pressure with no moving parts. Descriptive text and icon labelling describes functionality and is available in a range of languages.



Finishes

Glass fascia finishes



Black

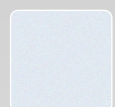

White

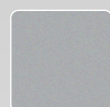

Silver

Rim finishes

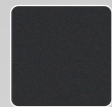

Magnesium

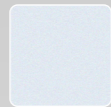

White

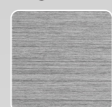

Aluminium



Chrome

Layouts

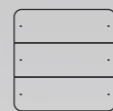

Features



Halo effect



Bulk Uploads



Temperature & humidity sensors



Proximity detection

Touchscreens

PDTS empowers the user, putting them in charge of all their intelligent building systems including lighting, shading, heating, cooling, ventilation and more.

Designed with simple navigation and intuitive layouts, or with a completely customised interface, PDTS improves access to personalised control, enabling the user to adjust and save settings at will.



Dynalite Touchscreen

The Dynalite PDTs Colour Touchscreen offers intelligent control and direct access to scheduling, scene editing, diagnostics and local environmental sensing.





Combining Ethernet connectivity, a powerful onboard processor, and contemporary design cues from the Antumbra user interface range, the PDTs is a sleek, functional complement to any project. The interface can be customised all automation elements from one location.

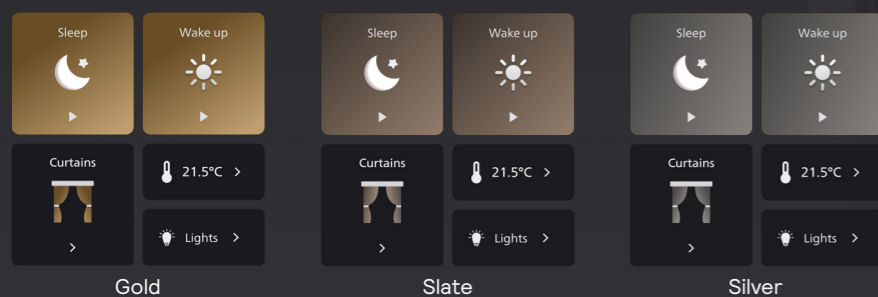

Display Themes



Features

-  Multiple pages
-  Temperature & humidity sensors
-  Bulk Uploads
-  Proximity detection

Mobile apps



The Dynalite Control App has a simple streamlined interface that delivers intuitive automated control into the hands of the end user.

Mobile apps

Manage all the technologies that run your home from your tablet or smartphone using our mobile Apps, no matter where you are. You can remotely monitor all systems and schedules from one device.

Arrange multiple systems into preset scenes. For example, 'Good Morning', 'Welcome Home' and 'After Hours' settings with your preferences for lighting, heating, entertainment systems and blinds, can all be recalled with one touch of a button to create exactly the right environment.

The mobile app will handle all of your smart home retirements. It is an intuitive and simple-use app with standard icons and themes using a consistent design language. The layout reflects the rooms and spaces in your residence delivering a tailored solution.



iPhone with Control App



Android with Control App

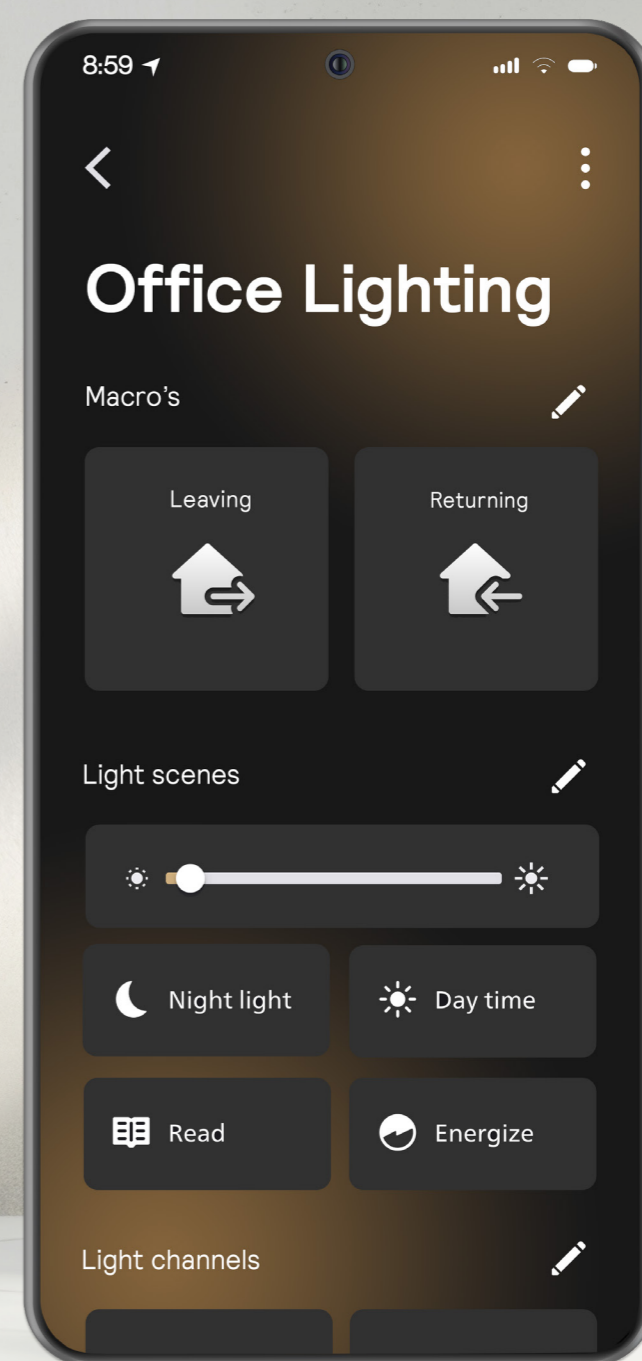

Personalise

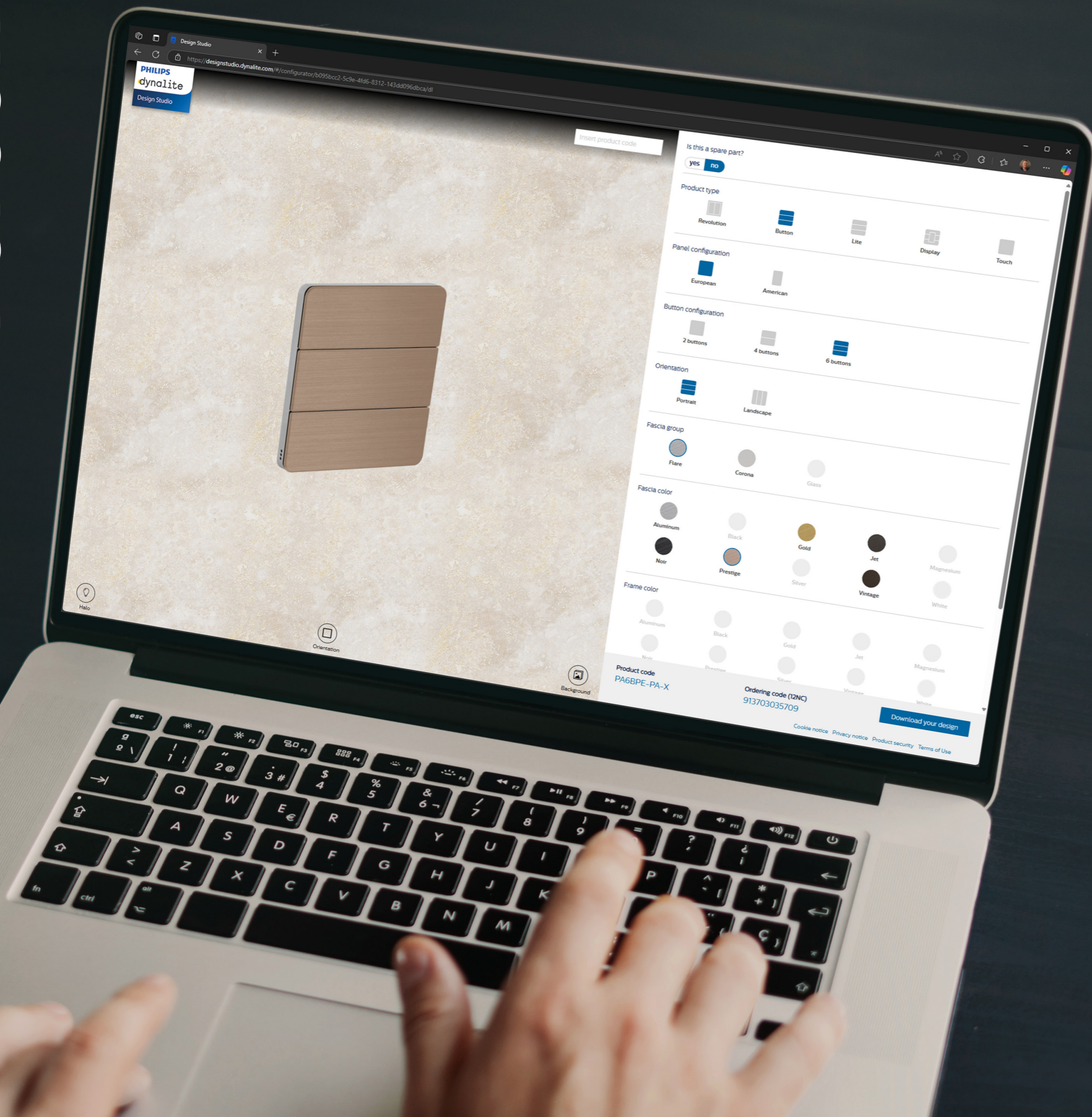

Design Studio

Dynalite Design Studio is a streamlined, intuitive design tool that helps you to create the right user interface for your project, both functionally and aesthetically. Build your perfect interface with no need to memorise complex part numbers or ordering codes.

Follow the Design Studio's easy steps to select from the full variety of panel types, orientations, fascia/rim finishes, and button labelling options. When you are satisfied with your choices, you can download a PDF of your final design for easy inclusion in your purchase order. <https://designstudio.dynalite.com>



Technical

Revolution Series

Ordering Information

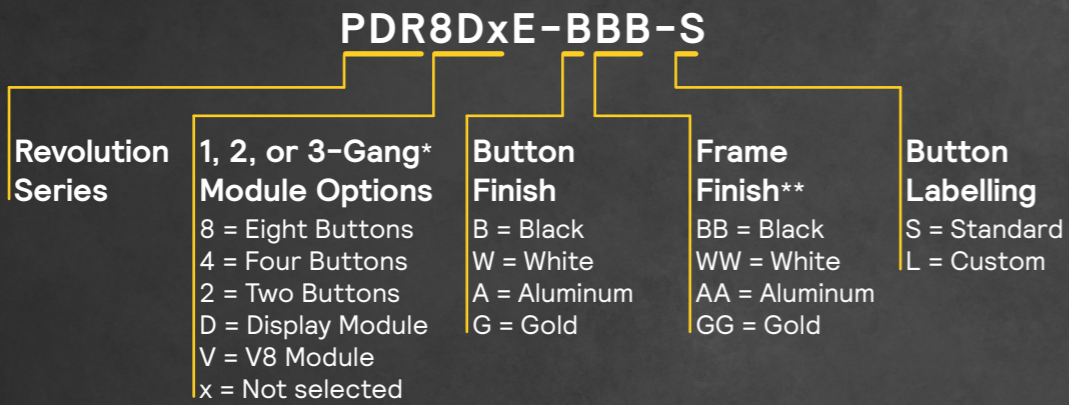

Example

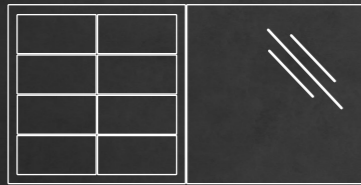

Dimensions

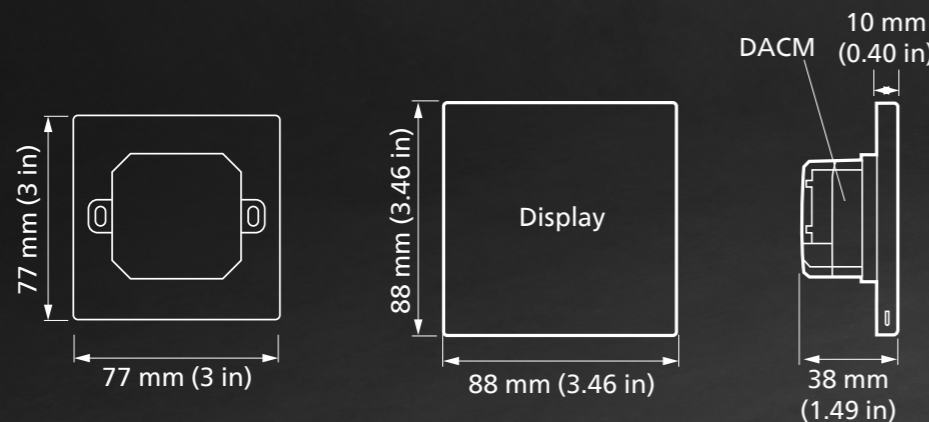
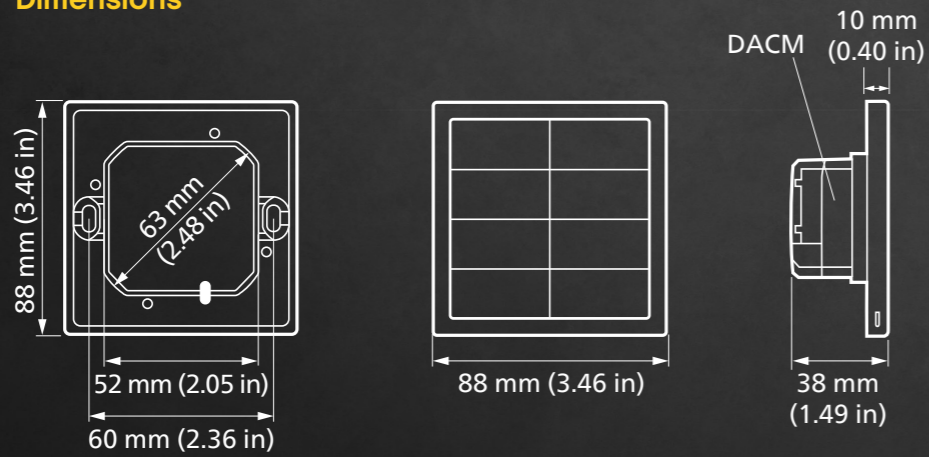

Antumbra Series

Ordering Information

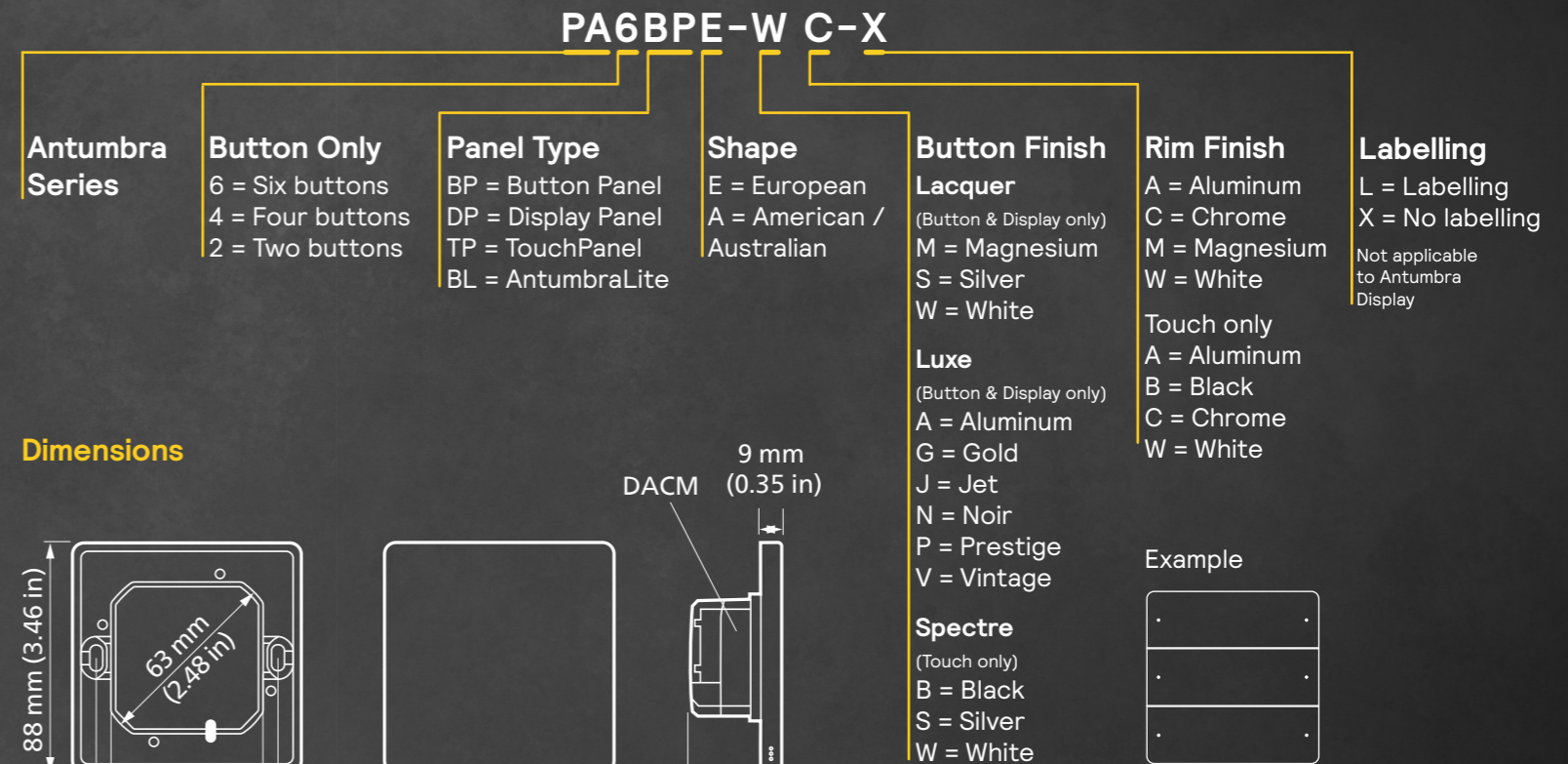

Dimensions

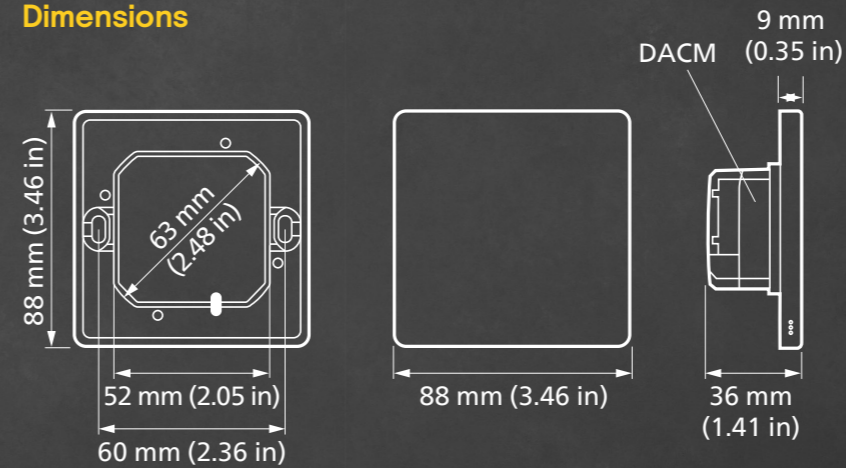

PDTS Touchscreen

Ordering Code: 913703334309

Dimensions

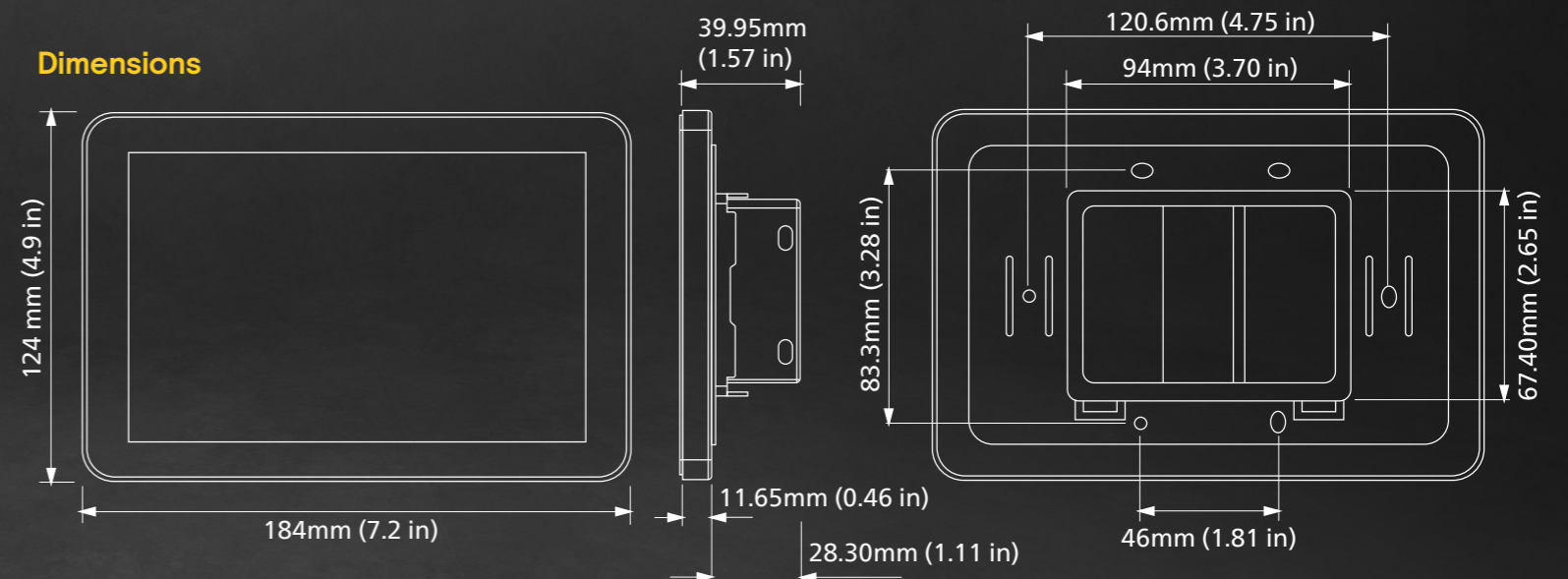



www.dynalite.com

© 2025 Signify Holding.

All rights reserved. Specifications are subject to change without notice. No representation or warranty as to the accuracy or completeness of the information included herein is given and any liability for any action in reliance thereon is disclaimed. Philips and the Philips Shield Emblem are registered trademarks of Koninklijke Philips N.V. All other trademarks are owned by Signify Holding or their respective owners.